

**PAMS Technical Documentation  
NSC/W-1/3 Series Transceivers**

**Disassembly &  
Troubleshooting  
Instructions**

**CONTENTS**

	<b>Page No</b>
Disassembly .....	3
Introduction .....	5
Abbreviations in RF-fault finding charts .....	5
Interface signals between RF and BB/DSP .....	6
Trouble Shooting .....	10
Phone is totally dead .....	10
The phone doesn't register to the network .....	11
Flash programming doesn't work .....	12
Power doesn't stay on, or phone is jammed .....	14
Display Information: Contact Service .....	16
Audio failure .....	17
Charging failure .....	19
Receiver Fault AMPS .....	20
General Instructions .....	20
Path of the received signal .....	20
Receiver Fault AMPS .....	21
Receiver Fault TDMA800 .....	23
Receiver Fault TDMA1900 (only for dualbander) .....	25
Transmitter Fault – General .....	27
Path of the transmitted signal .....	27
Transmitter Fault AMPS .....	28
Transmitter Fault TDMA800 .....	30
Transmitter Fault TDMA1900 .....	31
Power Control Loop .....	33
Synthesizers .....	34
19.44 MHz reference oscillator .....	34
58.32 MHz 3-multiplier .....	34
19.44 MHz oscillator and 3-multiplier troubleshooting ..	35
VHF VCO .....	36
VHF VCO troubleshooting .....	37
AMPS & TDMA UHF SYNTHESIZER .....	38
1GHz UHFsynthesizer troubleshooting .....	38
TDMA1900 UHF Synthesizer 2 GHz (DUALBANDER) ..	39
2 GHz UHF synthesizer troubleshooting .....	39
About RF ASICs and MMIC PA .....	40
General information .....	40
PLUSSA ASIC .....	40
Receiver front ends .....	42
MMIC Power Amplifiers .....	42
PENTA regulator .....	43
TDMA1900 UP CONVERTER .....	44
TDMA1900 PLL .....	44

## Disassembly

**NOTE:** Do not attempt antenna removal while the covers are on. The antenna can be removed only when the phone covers are off

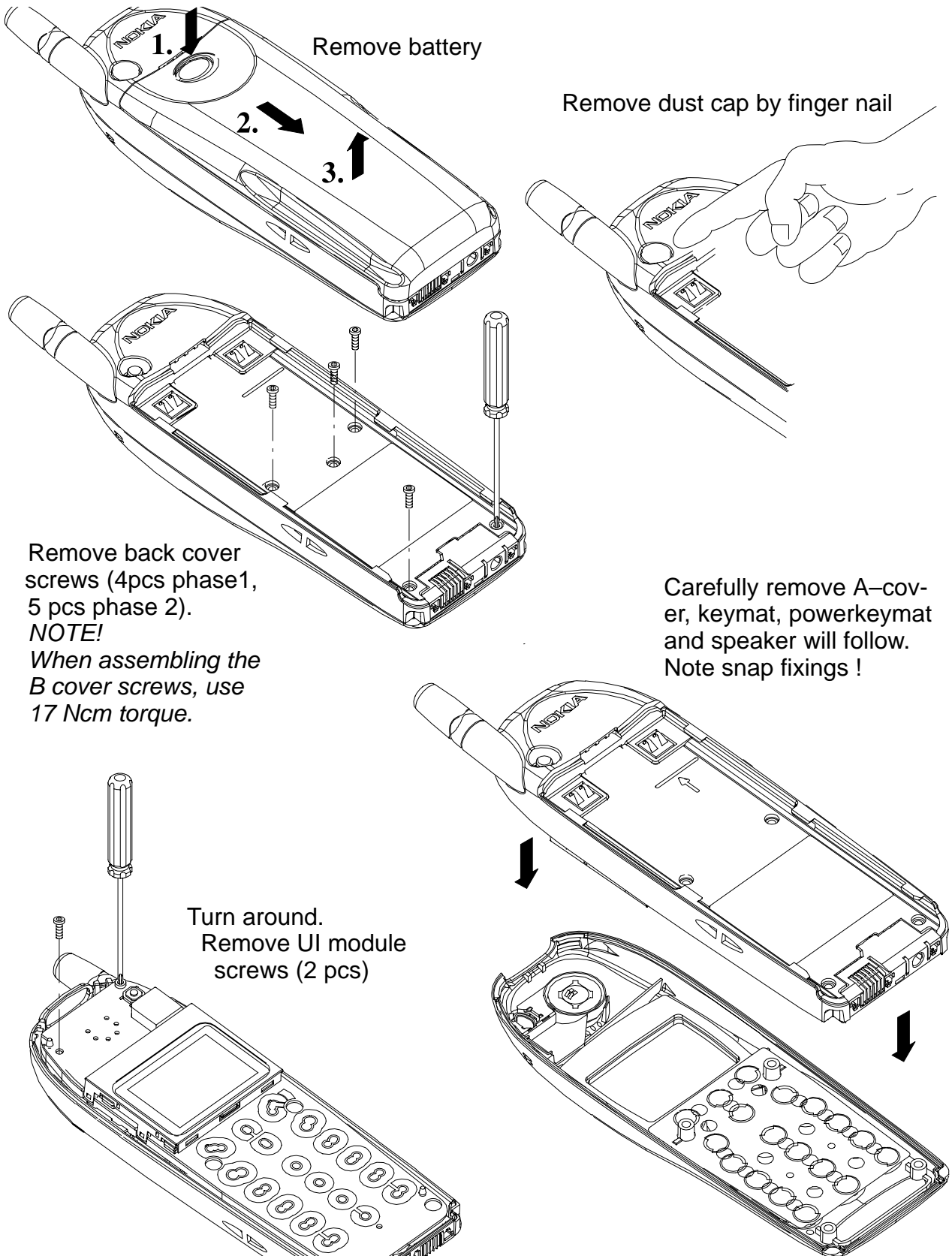

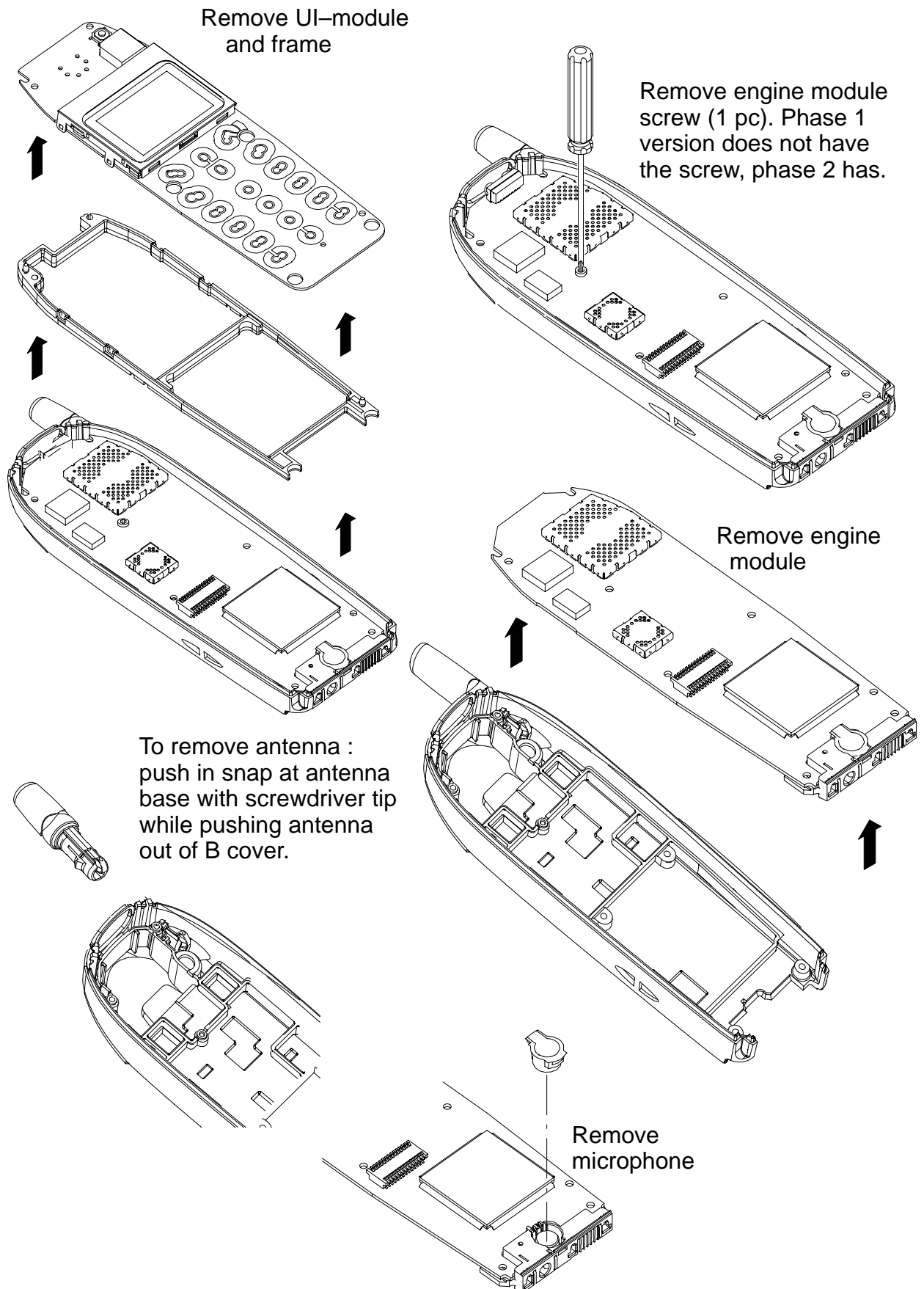

## Introduction

RF-measurements must be done using a spectrum analyzer and an high-frequency probe. (Local and reference frequencies and RF power levels in the intermediate stages of the chain) Oscilloscope is used to measure DC-voltages and low frequency signals. Multimeter is also a useful measurement equipment in fault finding.

The external RF connector must be used when reasonable to improve the reliability of the measurement results.

The RF-section is mainly built around the PLUSSA IC (N750). The RF block has separate external filters, UHF synthesizer, Power Amplifier , TX Driver, frontend and upconverter circuit for both frequency bands. In the TDMA1900 mode the external regulator is used to provide supply voltage for RF parts.

Before changing single ASICs or components, please check the following :

1. The soldering and connections of pins of the ASICS are OK
2. Supply voltages and control signals are OK
3. Signals of the synthesizers are coming to ASICS. This to prevent the unnecessary changing of the ASICS.

*NOTE! Grounding of the PA-IC is directly underneath so it is hard to check. **The PA-module is static discharge sensitive!** So ESD protection must be used when dealing with PA-IC (ground straps and ESD soldering tools). The PA is also a moisture sensitive components and it is important to follow additional information about handling the component.*

There are still lots of discrete components (resistors, inductors and capacitors) troubleshooting of which comprises just checking that the component is soldered or it is not missing from PCB.

### Abbreviations in RF-fault finding charts

TP	Test Point
BB	Baseband
f:	Frequency of signal (measured with spectrum analyzer)
LO	Local Oscillator
P:	Power of signal in desibels (dB) (measured with spectrum analyzer)
PA	Power Amplifier
PCB	Printed Circuit Board
PLL	Phase Locked Loop
RF	Radio Frequency
RX	Receiver
T:	Time between pulses
TX	Transmitter
UHF	Ultra High Frequency
V:	Voltage of signal (measured with oscilloscope)
VCO	Voltage controlled oscillator
VHF	Very High Frequency
AF:	Audio Frequency

## Interface signals between RF and BB/DSP

Signal name	From	To	Parameter	Minimum	Typical	Maximum	Unit	Function
VBAT <u>NOTE!</u> <u>Not charger</u>	Battery	RF	Voltage	3.1	3.6	5.3 <u>5.0</u>	V	Supply voltage for RF
VREF	CCONT	PLUSSA	Voltage	1.478	1.500	1.523	V	Reference voltage for PLUSSA
RFTEMP	RF	CCONT	Voltage	0 <u>HOT</u>	1.4 <u>ROOM</u> <u>TEMP</u>	2.7 <u>COLD</u>	V	RF temperature sensor 47k NTC to GND
AFC	COB-BA_D	VCTCXO <sub>c</sub>	Voltage	0.05	1.1	2.25	V	Automatic frequency control
AGC1	Cobba_D	PLUSSA	Voltage	0.5		1.4	V	
AGC2	MAD	RX LNA	Voltage	0		2.85	V	LNA Gain switch "1" min 2.0 V "0" max 0.7 V
BAND	COB-BA_D	VHF VCO	Voltage	0		2.85	V	"0" 2 GHz "1" 1 GHz
MODE	MAD	1GHz PA	Voltage	0		2.85	V	"0" AMPS "1" TDMA
IF2AP/ IF2AN	PLUSSA	COB-BA_D	Voltage/Frequency		0.6 / 450		Vpp / kHz	Differential limiter output to DEMO detector
IF2DP / IF2DN	PLUSSA	COB-BA_D	Voltage/Frequency		170 / 450	1400	mVpp / kHz	Differential IF2-signal to RX A/D-converter
SENA1	MAD	PLUSSA	Logic high "1"	2.0			V	1 GHz PLL enable
			Logic low "0"	0		0.8	V	
SDATA	MAD2	PLUSSA	Logic high "1"	2.0			V	Synthesizer data
			Logic low "0"	0		0.8	V	
SCLK	MAD2	PLUSSA	Logic high "1"	2.0			V	Synthesizer clock
			Logic low "0"	0		0.8	V	
RFC	VCTCXO	COB-BA_D	Voltage/Frequency	0.2	0.4 / 19.44	1.0	Vpp / MHz	Clock signal for the logic circuits

RFCEN	MAD	CCONT / PENTA regulator	Voltage	0		2.85	V	"1" min 2.0 V "0" max 0.4 V	
RSSI	PLUSA	CCONT	Output level	0.1		1.5	V	Analog mode field strength indicator	
TXIP/ TXIN	COBBA	PLUSA	Differential voltage swing (static)	1.022	1.1	1.18	V <sub>pp</sub>	Differential in-phase TX baseband signal for the RF modulator	
			Output level on each output	0.760	0.8	0.84	V		
TXQP/ TXQN	COBBA	PLUSA	Same as TXIP/ TXIN						Differential quadrature phase TX baseband signal for the RF modulator
TXP1	MAD	CCONT	Logic high "1"	2.0			V	1 Ghz Transmitter power control enable	
			Logic low "0"			0.5	V	VR7 ON/OFF	
TXC	COBBA	PLUSA	Number of bits	10			bits	Transmitter power control (ramps & power levels)	
			Output voltage swing	2.09	2.15	2.21	V		
			Minimum code output level	0.12	0.15	0.18	V		
			Maximum code output level	2.27	2.3	2.33	V		
TXF	PLUSA	MAD	Voltage	0		2.85	V	False transmission indicator, function controlled via PLUSA register	
TXP2	MAD	PENTA regulator	Logic high "1"	2.0			V	2 Ghz Transmitter power control enable	
			Logic low "0"			0.5	V	VR11 ON/OFF	
TXA	MAD	PLUSA	Logic high "1"	2.5			V	PWR control loop during TX burst	

			Logic low "0"			0.2	V	PWR control loop during ramp up/down
TXLX1	MAD	RF TDMA 800	Logic high "1"	2.1			V	Low power level mode for power detector
			Logic low "0"			0.6	V	High power level mode for power detector
TXLX2	MAD	RF TDMA 1900	Logic high "1"	2.1			V	Low power level mode for power detector
			Logic low "0"			0.6	V	High power detector mode power detector
SENA2	MAD	2 Ghz UHF PLL	Logic high "1"	2.0			V	2 Ghz PLL enable
			Logic low "0"	0		0.8	V	
RXPWR1	MAD	CCONT	Logic high "1"	2.0			V	VR4 ON
			Logic low "0"	0		0.8	V	VR4 OFF
RXPWR2	MAD	PENTA	Logic high "1"	2.0			V	VR8 ON, 1Ghz front-end
			Logic low "0"	0		0.8	V	VR8 OFF
RXPWR3	MAD	PENTA	Logic high "1"	2.0			V	VR9 ON 2Ghz front-end
			Logic low "0"	0		0.8	V	VR9 OFF
SPWR1	COB-BA_D	CCONT	Logic high "1"	2.0			V	VR2 ON , 1Ghz UHF
			Logic low "0"	0		0.5	V	VR2 OFF
SPWR2	COB-BA_D	CCONT	Logic high "1"	2.0			V	VR3 ON, VHF ON/OFF
			Logic low "0"	0		0.5	V	VR3 OFF
SPWR3	COB-BA_D	PENTA	Logic high "1"	2.0			V	VR10 ON , 2Ghz UHF
			Logic low "0"	0		0.5	V	VR10 OFF
TXPWR1	MAD	CCont	Logic high "1"	2.0			V	VR5 ON , TX pwr control enable
			Logic low "0"	0		0.5	V	VR5 OFF



TXWR2	MAD	PENTA	Logic high "1"	2.0			V	VR12 ON , TDMA1900 TX-mixer enable
			Logic low "0"	0		0.5	V	VR12 OFF
TXWR3	MAD	TDMA800 TX-mixer	Logic high "1"	2.0			V	AMPS & TDMA800 TX-mixer enable
			Logic low "0"	0		0.5	V	TX-mixer disable
VR1	CCont	RF	Voltage	2.7	2.8	2.85	V	Supply for VCTCXO, Plusa VHF prescaler and bias, 2 Ghz PLL and 3x
VR2	CCont	RF	Voltage	2.7	2.8	2.85	V	Supply volt- age for 1GHZ UHF VCO and prescaler
VR3	CCont	RF	Voltage	2.7	2.8	2.85	V	Supply volt- age for VHF VCO, LO buffer, 1 Ghz TX-mixer and TXF
VR4	CCont	RF	Voltage	2.7	2.8	2.85	V	Supply volt- age for PLUSA IF- parts and IF- amplifier
VR5	CCont	RF	Voltage	3.1	3.6	5.3	V	Supply volt- age for modulator, TX pwr con- trol
VR6	CCont	RF	Voltage	2.7	2.8	2.85	V	Supply volt- age for PLUSA dig- ital parts and Cobba_D analog sup- ply
VR7	CCont	RF	Voltage	2.7	2.8	2.85	V	TX PA bias and driver supply
V5V	CCont	PLUSA	Voltage	4.8	5.0	5.2	V	Plusa and 2 Ghz PLL chargepump

## Trouble Shooting

The following hints should facilitate finding the cause of the problem when the circuitry seems to be faulty. This trouble shooting instruction is divided in following section.

1. Phone is totally dead
2. Flash programming doesn't work
3. Power doesn't stay on or the phone is jammed
4. Display information: Contact Service
5. Phone doesn't register to the network or phone doesn't make a call.
6. Audio fault.
7. Charging fault

The first thing to do is carry out a thorough visual check of the module. Ensure in particular that:

- a) there are not any mechanical damages
- b) soldered joints are OK

### Phone is totally dead

This means that phone doesn't take current at all when the power switch is pressed or when the watchdog disable pin (X101 pin 11) is grounded. Used battery voltage must be higher than 3.0 V. Otherwise the hardware of CCONT (N150) prevents totally from switching.

**The phone doesn't register to the network or phone doesn't make a call**

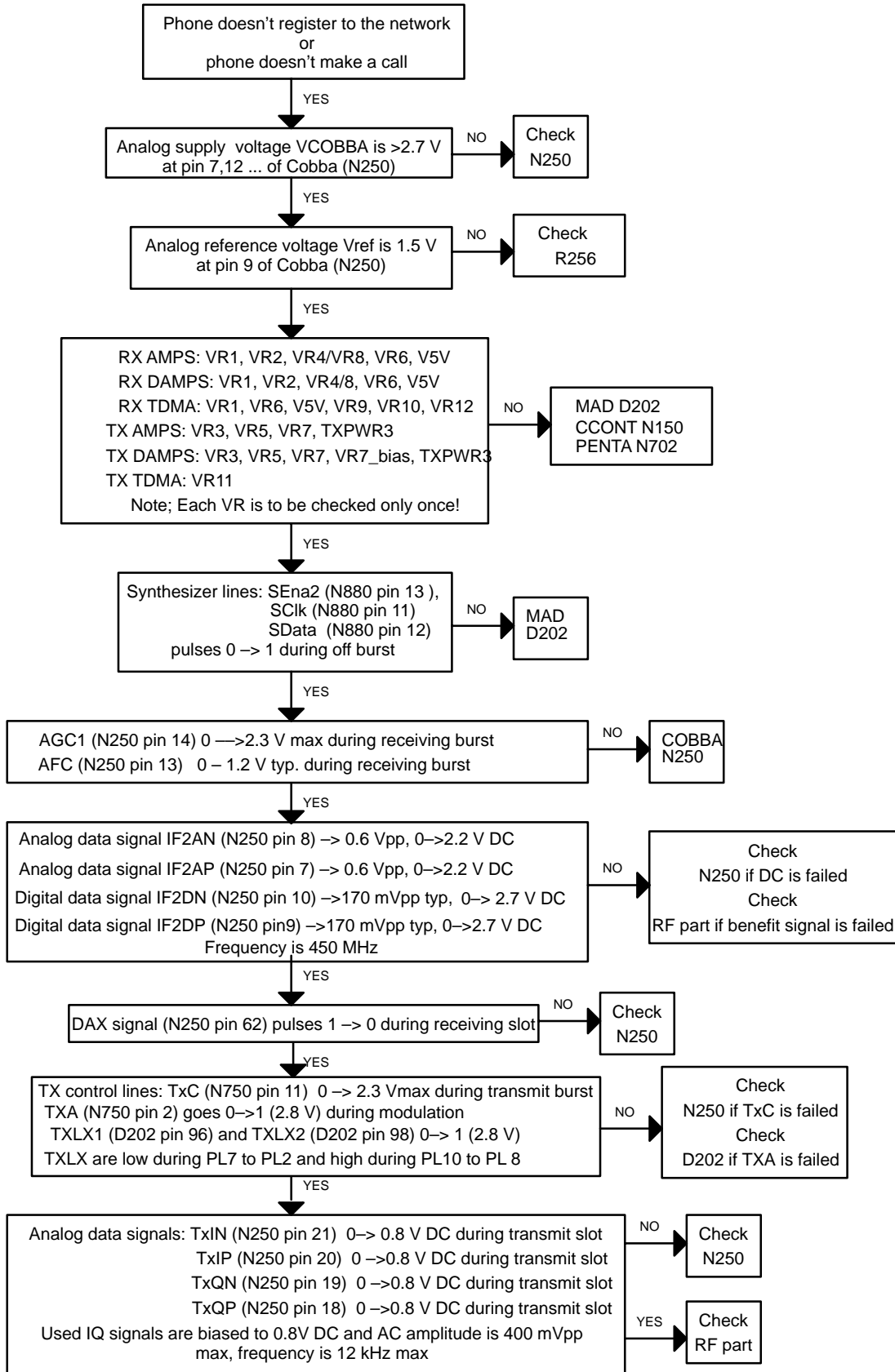

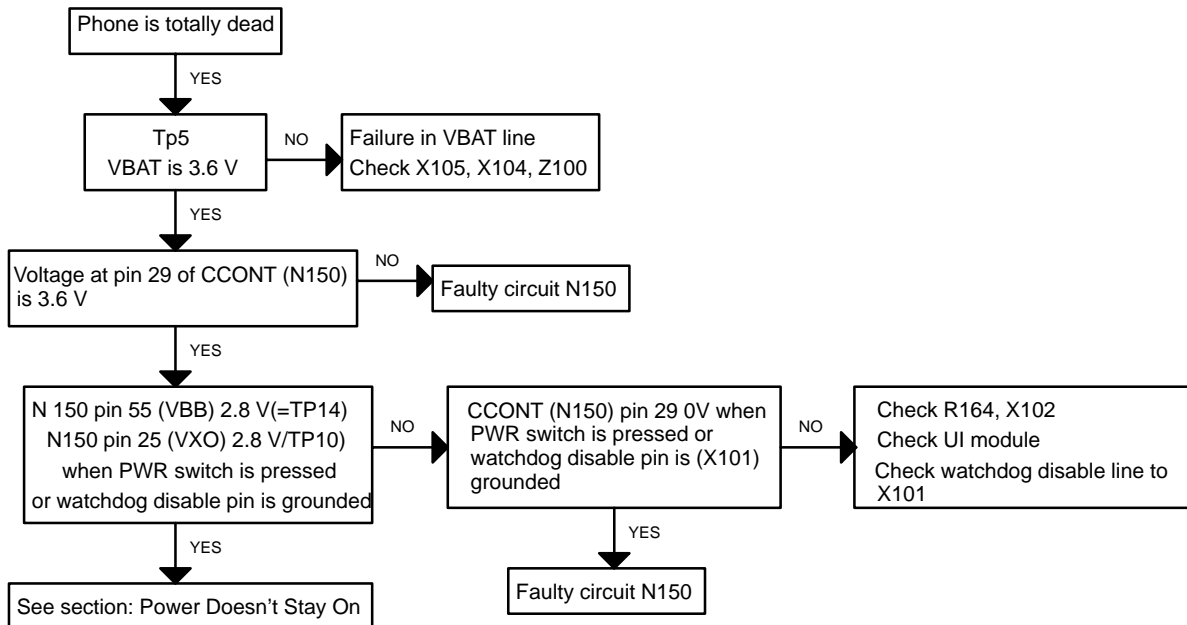

## Flash programming doesn't work

The flash programming can be done via panel connector X101 or via system connector X100.

The main differences between these are:

- a) FLASH programming voltage is produced different way.
- b) Signal routings are different.

In flash programming error cases the flash prommer can give some information about a fault.

The fault information messages could be:

- MCU doesn't boot
- Serial clock line failure
- Serial data line failure
- External RAM fault
- Algorithm file or alias ID doesn't find
- MCU flash Vpp error

In cases that the flash programming doesn't succeed there is a possibility to check short circuits between the memories and the MCU (MAD1).

This test is useful to do, when the fault information is: MCU doesn't boot, Serial clock line failure or Serial data line failure.

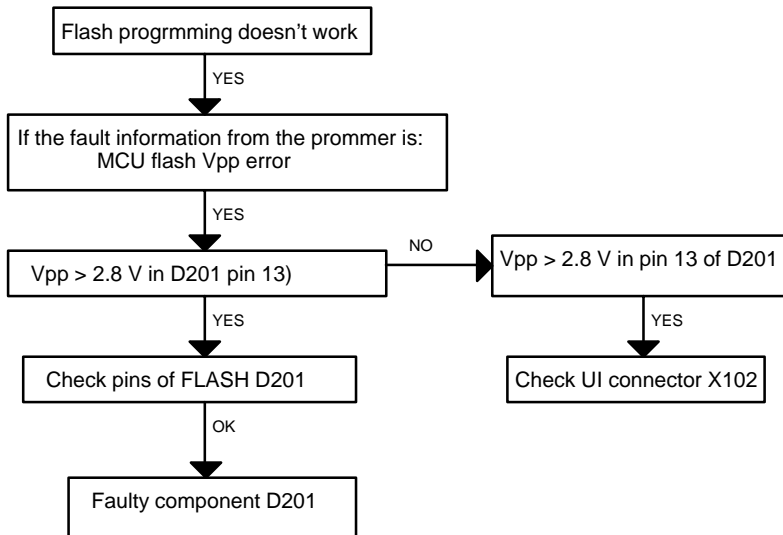
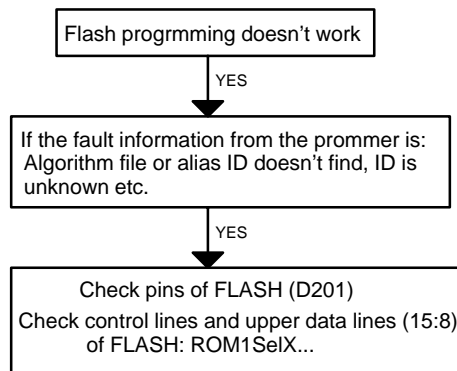
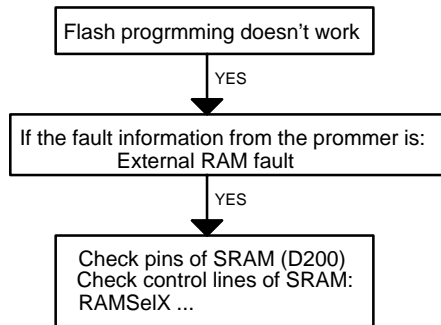

## Power doesn't stay on, or phone is jammed

If this kind of fault has come after flash programming, there are most probably open pins in ICs.

The soldered joints of ICs: D202 (MAD1), D201 (FLASH), N150 (CCONT), D200 (SRAM) are useful to check first.

Normally the power will be switched off by CCONT (N150) after 30 seconds, if the watchdog of the CCONT can not be served by software.

The watchdog updating can be seen by oscilloscope at pin 50 (DataSelX) of CCONT.

In a normal case there is a short pulse from "1" → 0 every 8 seconds.

The power off function of CCONT can be prevented by connecting a short circuit wire from CCONT pin 29 to ground.

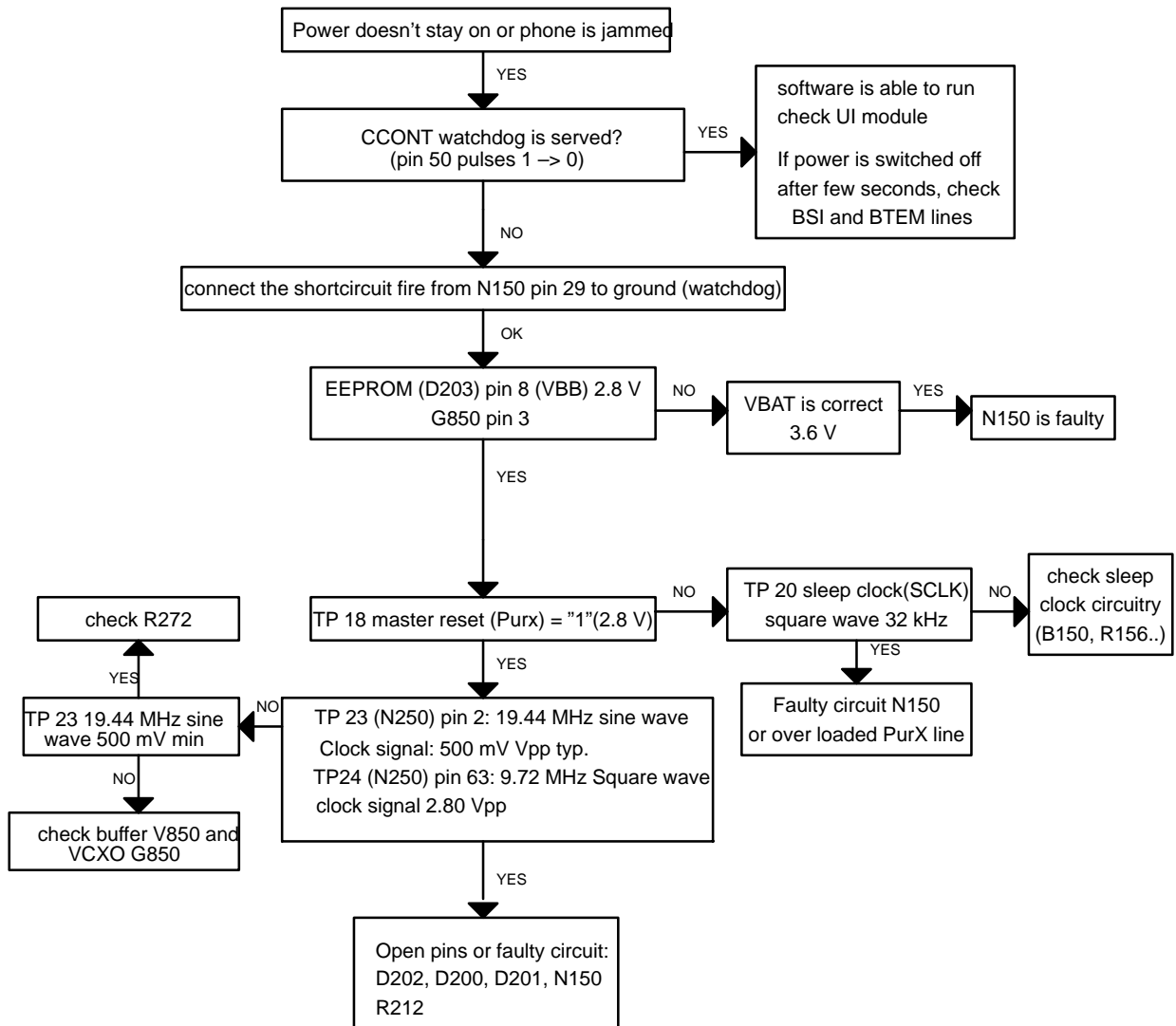

## Display Information: Contact Service

This fault means that software is able to run and thus the watchdog of CCONT (N150) can be served.

Selftest functions are run when power is switched on and software is started to execute from flash.

If any of selftests is failed, contact service information will be shown on display.



## Audio failure

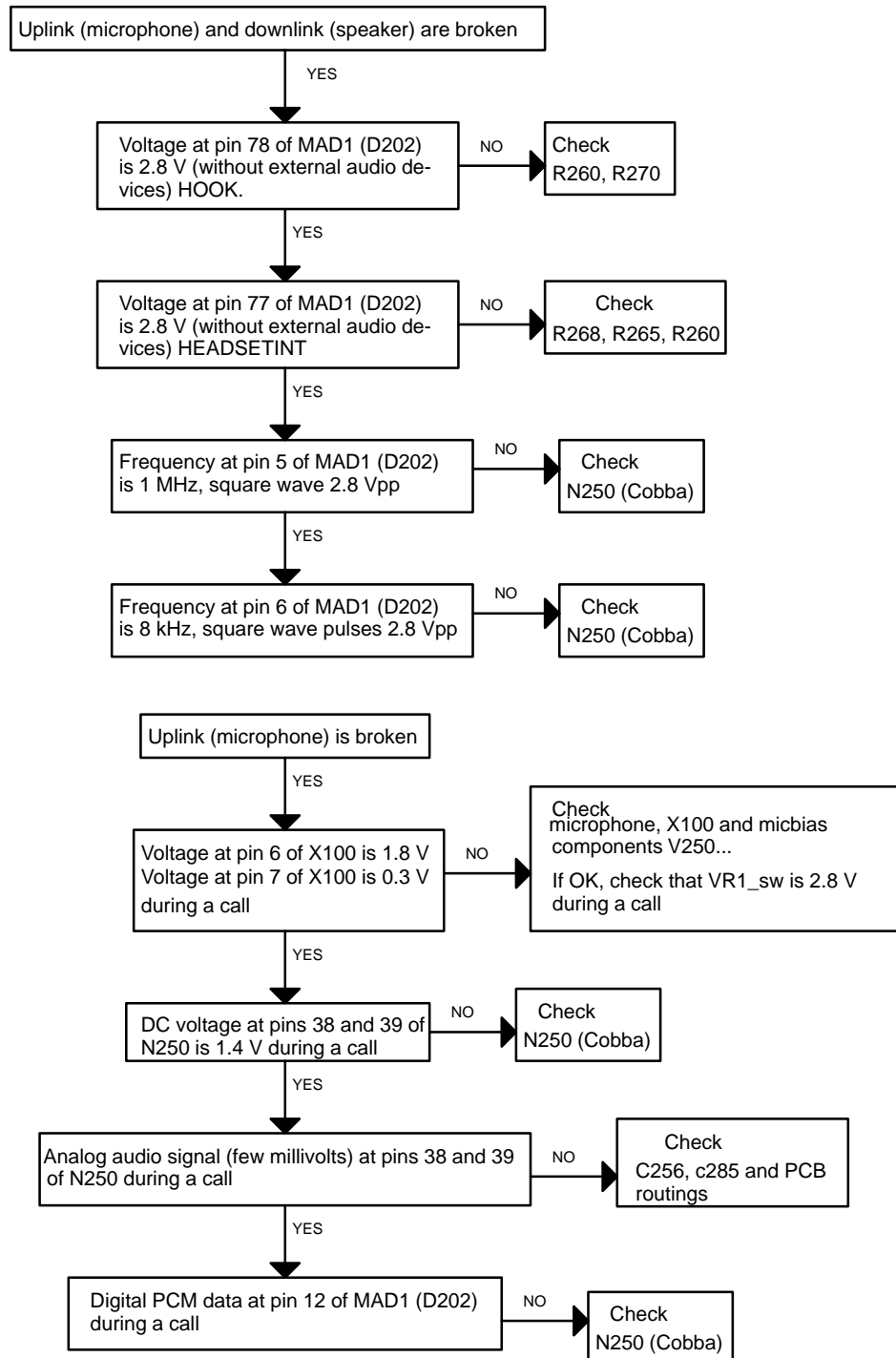

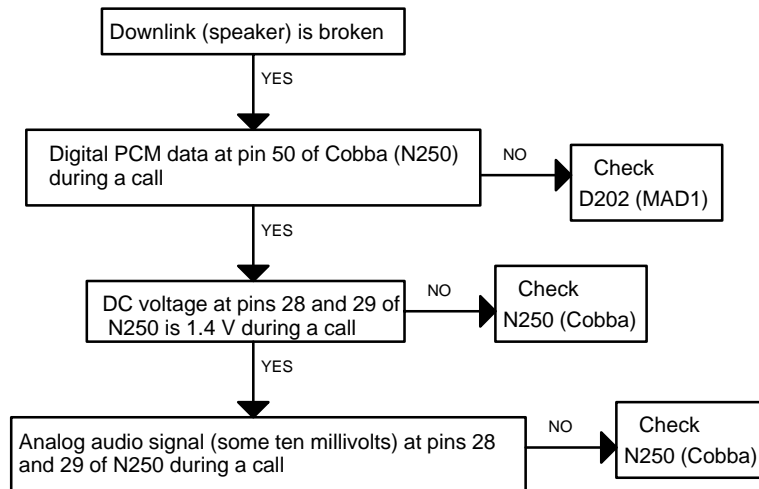

## Charging failure

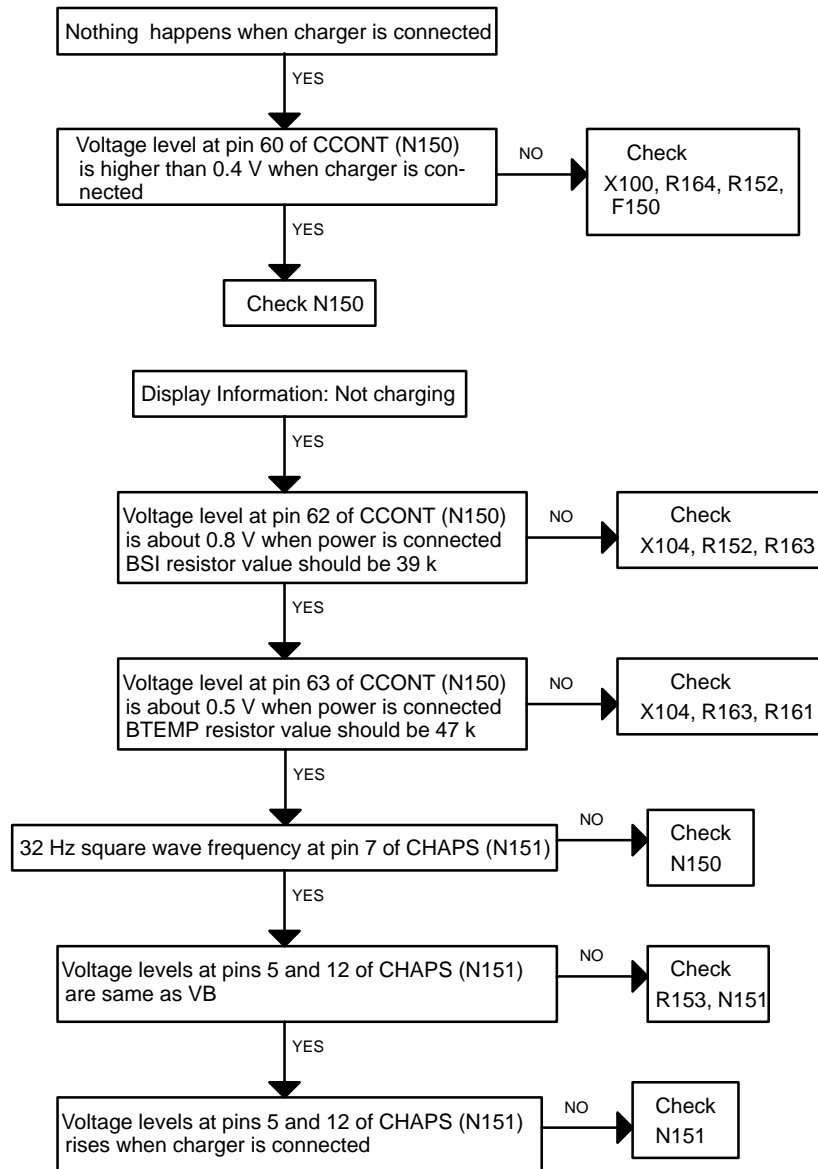

## Receiver Fault AMPS

### General Instructions

Start the WINTESLa software and use it to start the needed RX mode of the phone. The troubleshooting flow chart is divided into three steps:

- general checking,
- local checking
- RX-chain checking.

Make sure to check all solderings and the presence of all components before changing an ASIC or filter.

### Path of the received signal

Block level listing:

Path of the received signal
Antenna EXT RF
Duplexer
Low Noise Amplifier (LNA)
RX Filter
First Mixer
116.19 MJz filter
IF amplifier
ACG/Buffer
Second mixer
450 kHz fillter
Buffer/limiter
Baseband (FM detector)

The following fault finding charts are for the receiver chain.

## Receiver Fault AMPS

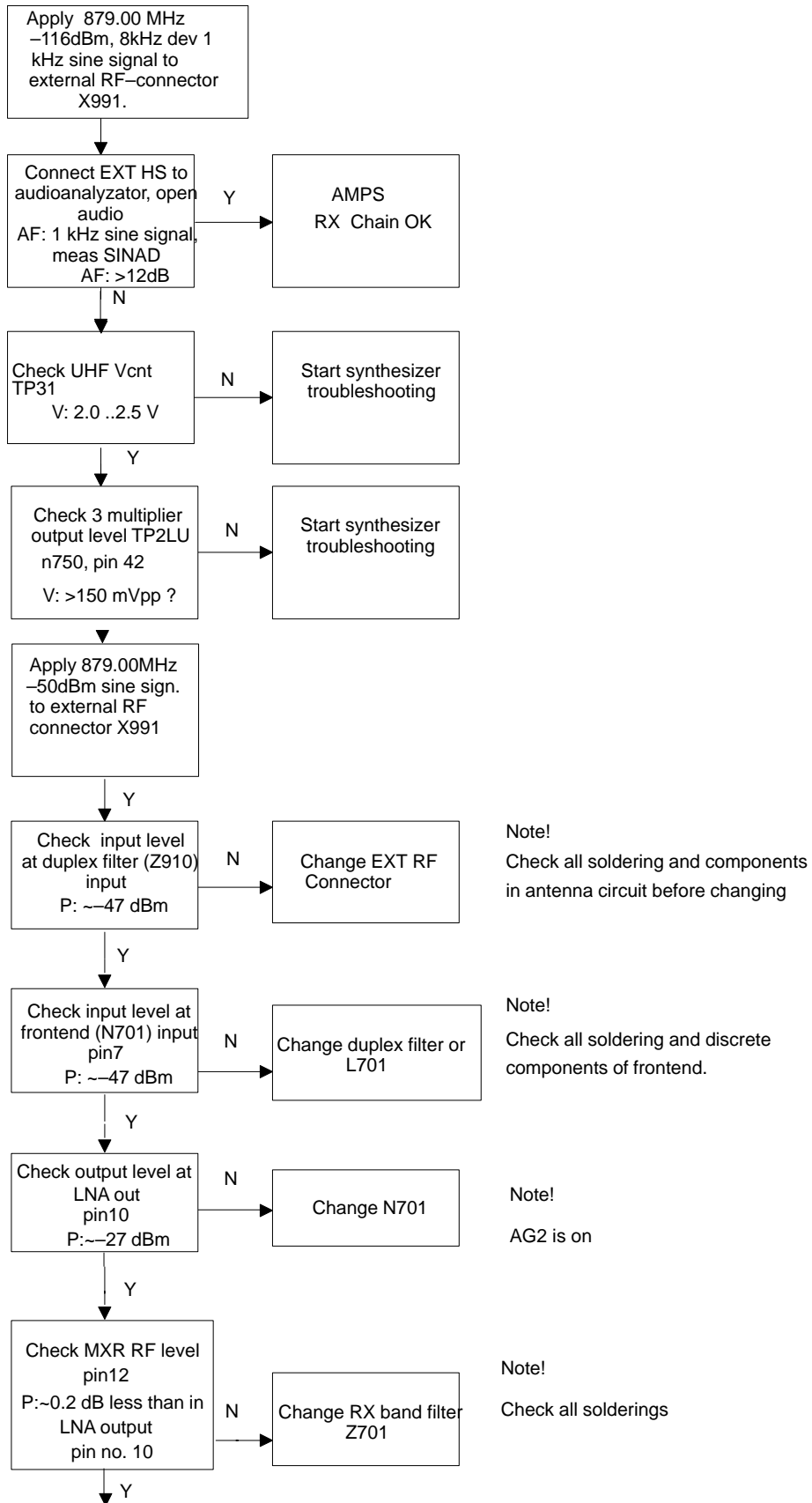

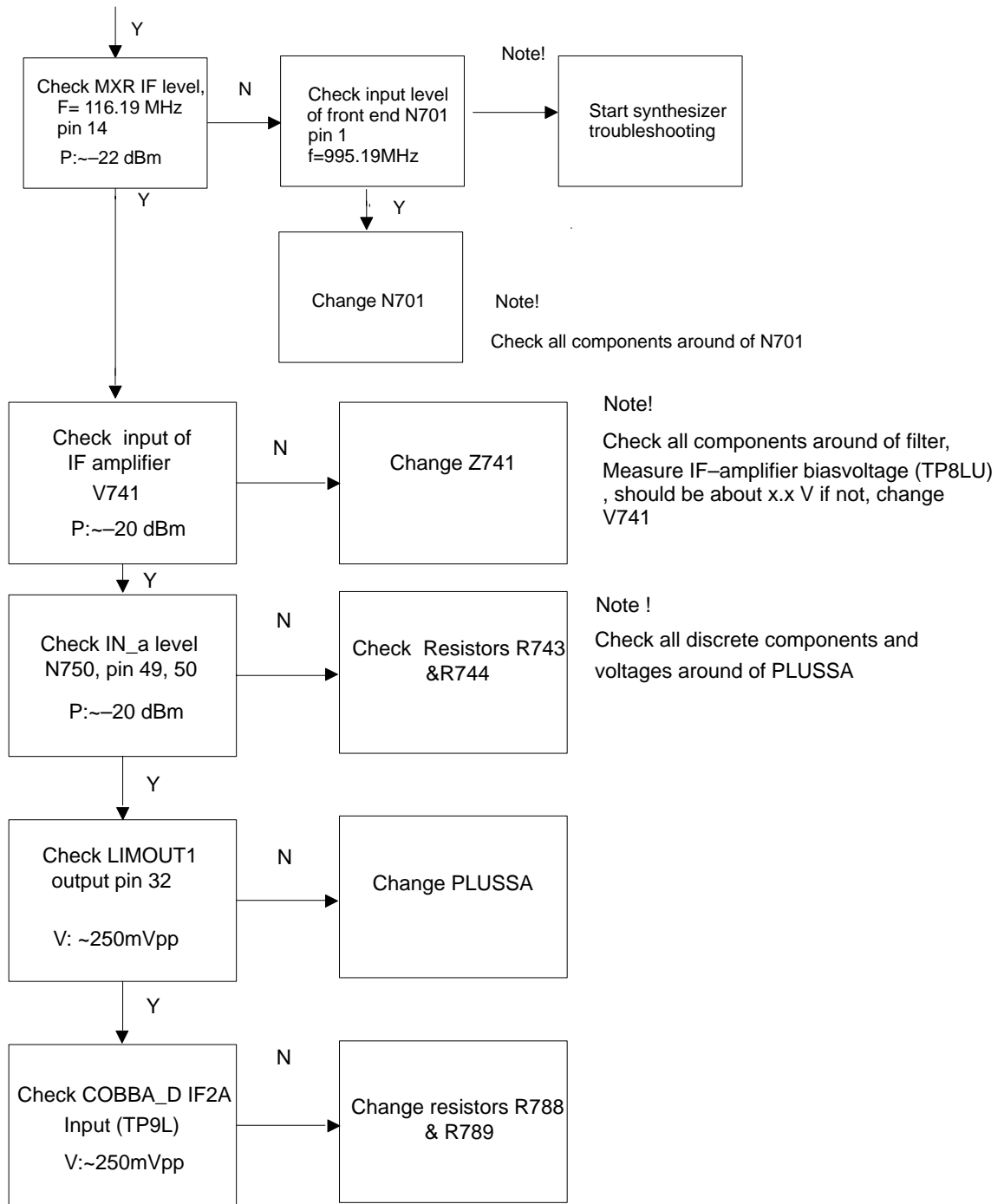

### Receiver Fault TDMA800

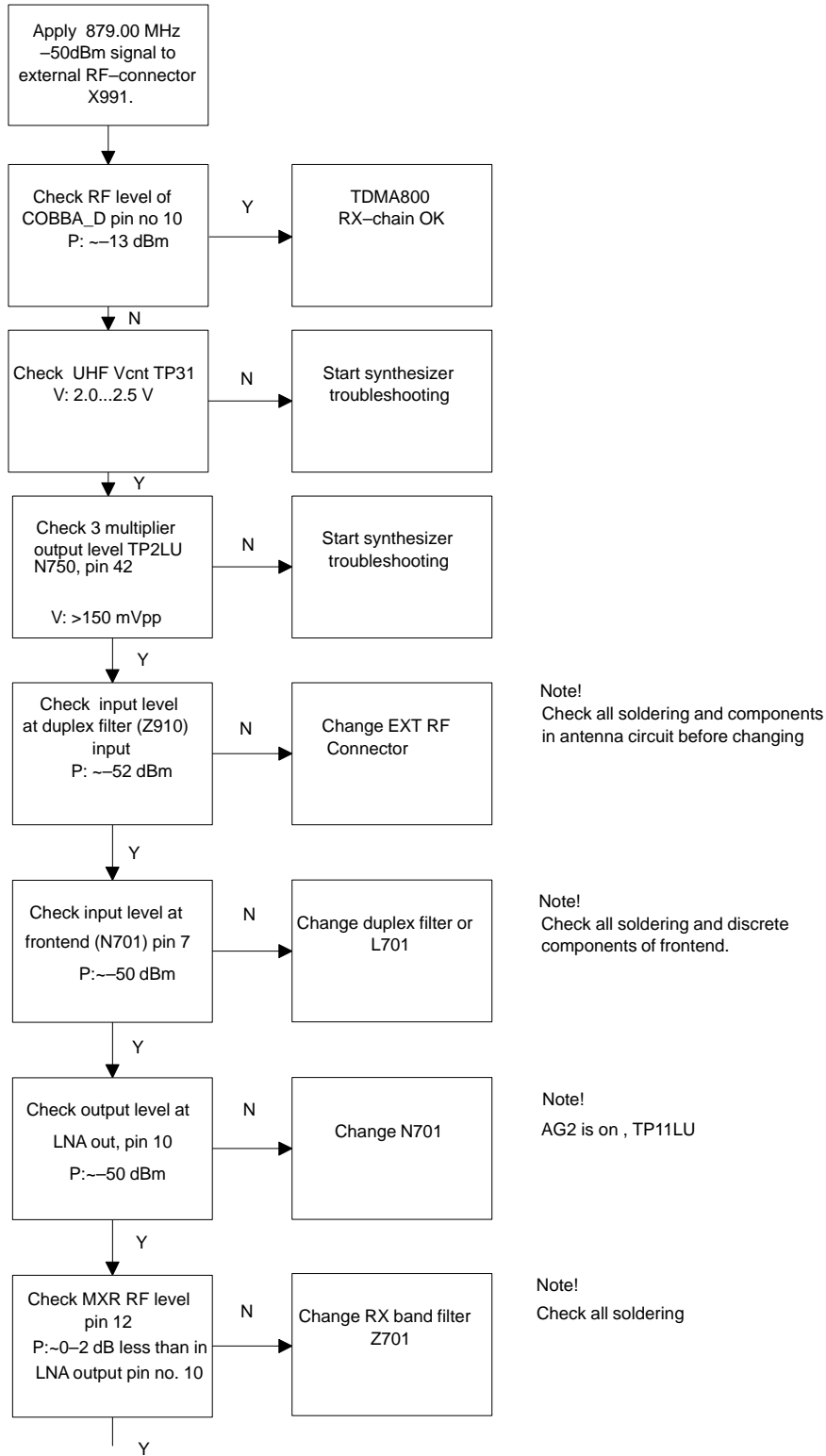

Note!  
Check all soldering and components  
in antenna circuit before changing

Note!  
Check all soldering and discrete  
components of frontend.

Note!  
AG2 is on , TP11LU

Note!  
Check all soldering

Check all components around of N701

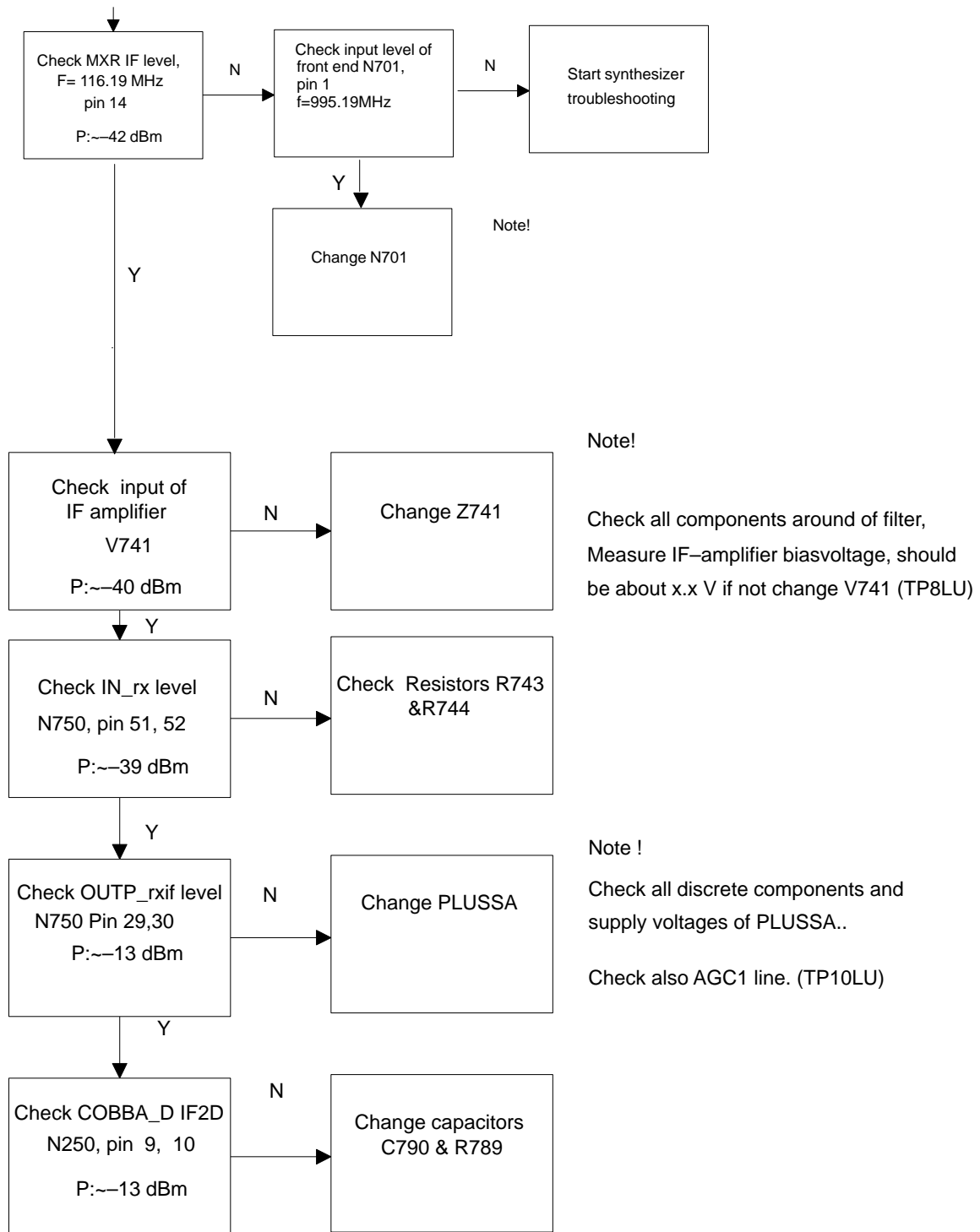



### Receiver Fault TDMA1900 (only for dualbander)

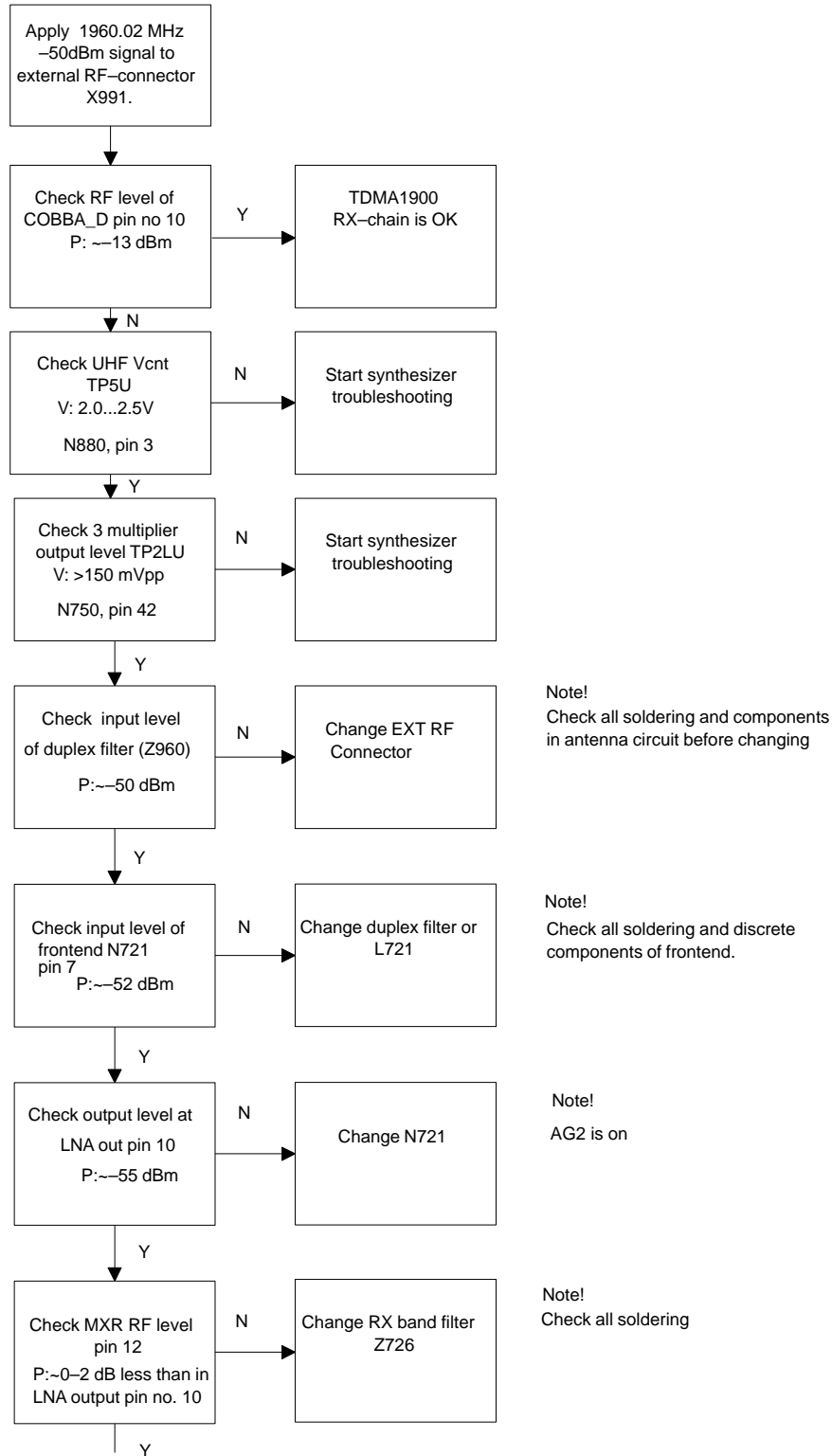

Check all components around of N721

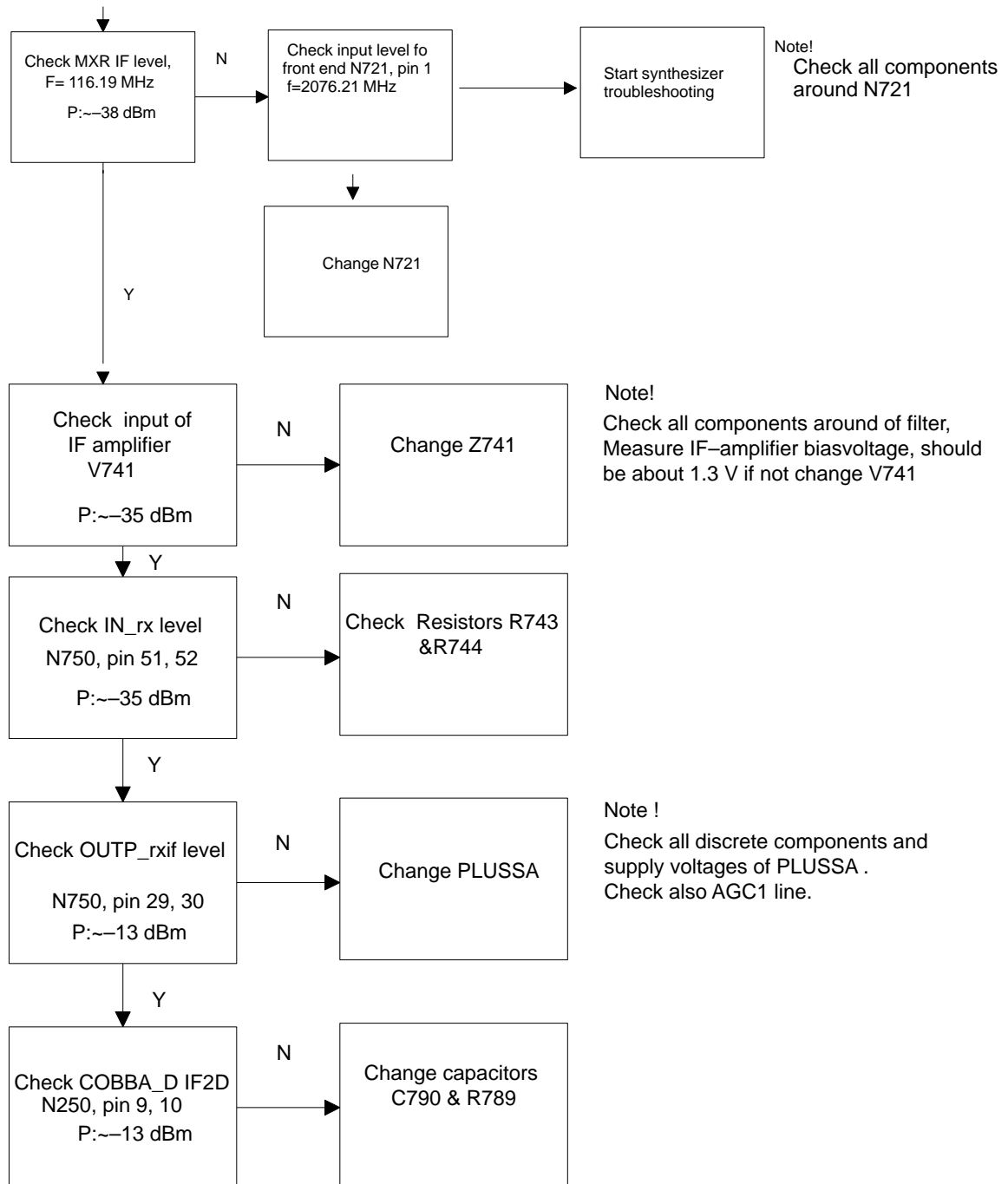

## Transmitter Fault – General

Always use a RF-cable connected from an external RF connector to the analyzer via a 10dB attenuator. This is important to protect the analyzer against excessive RF power and to not let unwanted RF power leak in the cellular frequencies.

Start the WINTESLA software and select the TX mode for testing (AMPS, DAMPS, or TDMA 1900). Select mid channel (383 for AMPS, DAMPS or 1000 for TDMA 1900) Select random data for digital mode of operation.

One of the basic test is to monitor current when transmitter is on. If the current consumption does not change when transmitter is turned on, the fault is in the PA. Also if pressing the PA chip more tightly to PCB does have an effect on current consumption, the fault is in PA.

In case of a faulty PA the IC can be changed only under correct (ESD) grounding and using only a hot air blower set to 10m/s and 300 degree centigrade. The new chip must be taken from its vacuum package and the heating process must be done in less than 30 second. Note that the bottom plate of the chip must be properly soldered and excessive solder material, if any, has to be remove.

If any components in the TX chain are replaced the power level tunings have to be checked and retuned.

### Path of the transmitted signal

Block level listing AMPS, DAMPS	Block level listing TDMA 1900
COBBA TX I/Q DA-converters	COBBA TX I/Q DA-converters
I/Q modulator and Digital gain step amplifier	I/Q modulator and Digital gain step amplifier
IF-BPF	IF-BPF
Upconverter	Upconverter
TX Driver	BPF
BPF	TX Driver
PA	BPF
Coupler	PA
Duplex filter	Coupler
Antenna matching circuit	Duplex filter
EXT RF connector	Antenna matching circuit
Antenna	EXT RF Connector
	Antenna

Power detection and power control circuit are included in the power control part of this guide.

Start the WINTESLA software and set the phone in Analog mode. Set Channel 383 and Power level 2. Apply the RF cable to Ext RF onnector and connect the cable to the spectrum analyzer input, measure the RF level. Notice the insertion loss of the cable and the attenuators. Use external attenuator to avoid overloading the spectrum analyzer.

### Transmitter Fault AMPS

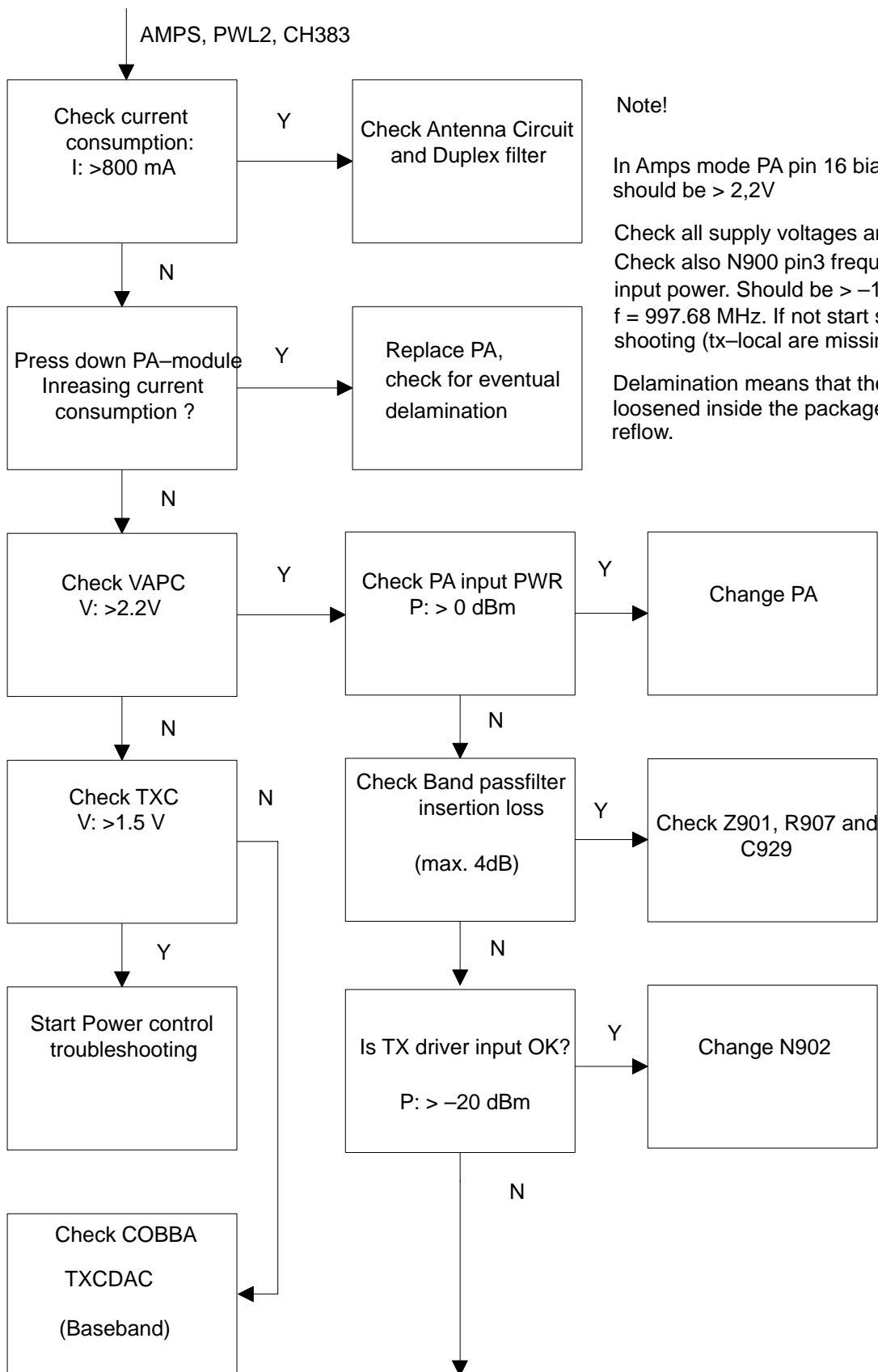

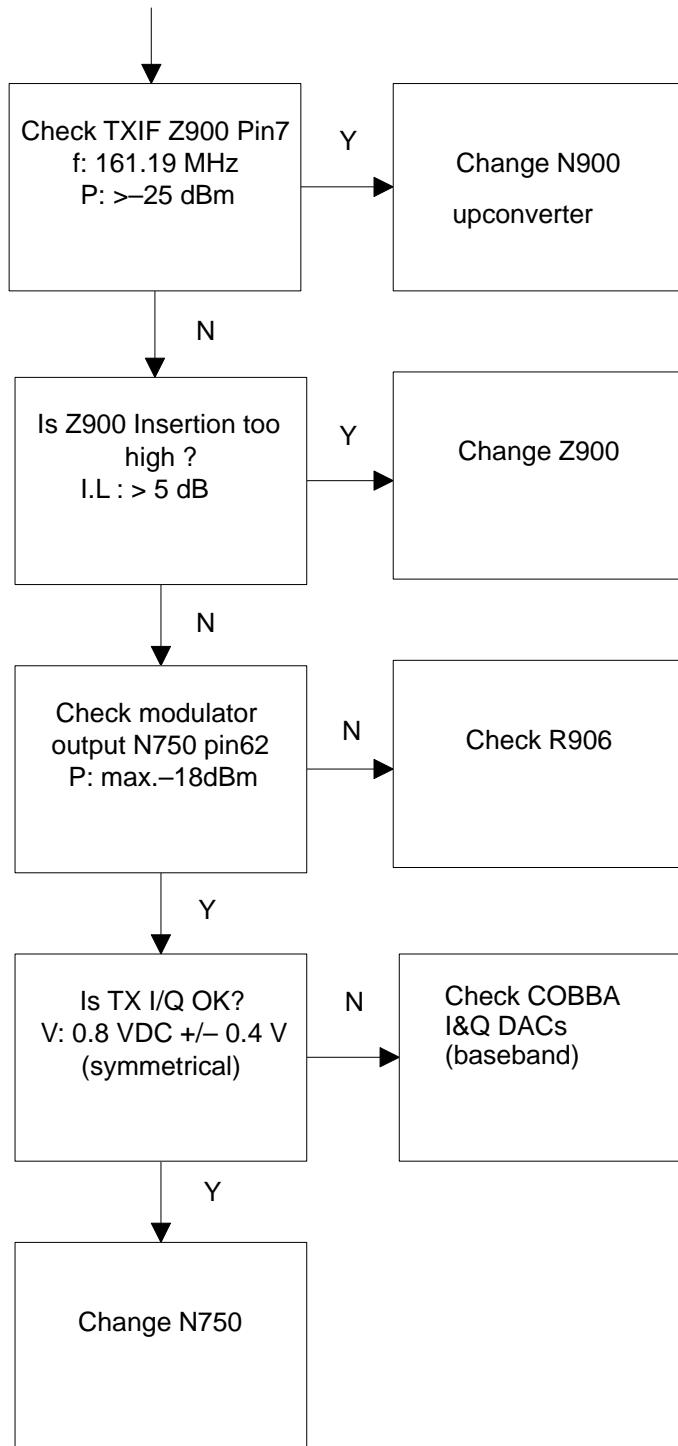

Note!  
check also I/Q-resistors

### Transmitter Fault TDMA800

The transmitter is the same as in AMPS mode, but the power amplifier is biased to more linear. Consequently it is essential that the AMPS is free of any faults.

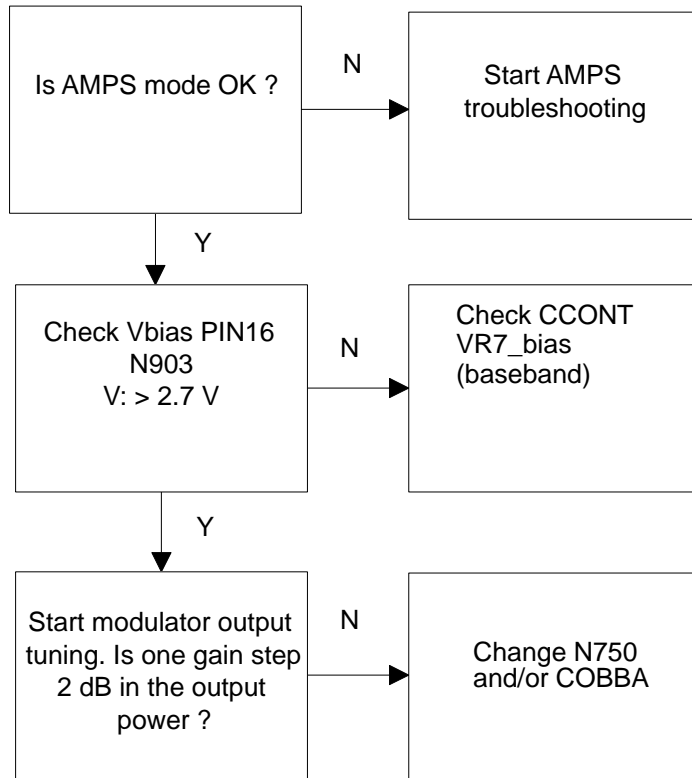

### Transmitter Fault TDMA1900

TDMA1900 and DAMPS modes share a common IF section and antenna circuit. Consequently it is essential that the DAMPS mode is free of any faults.

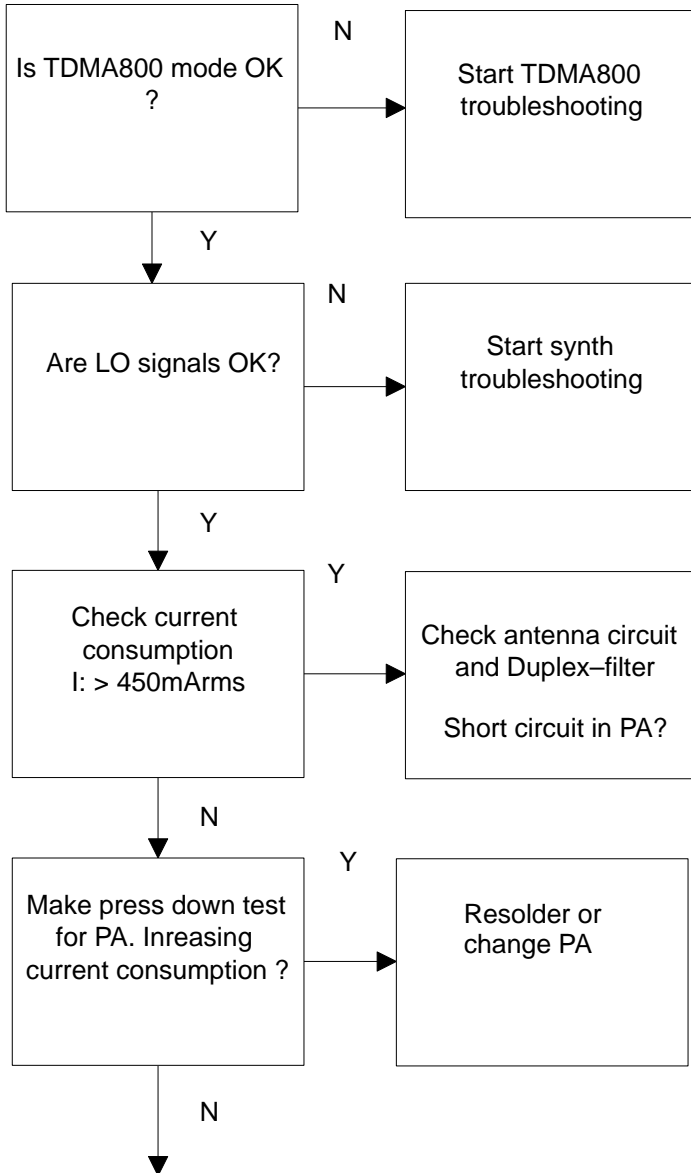

Note!

Check VHF and UHF locals including Lo-buffer, measuring point for UHF is N980 pin5.

Note!

The PA ground slug might be poorly soldered or there is delamination on chip.

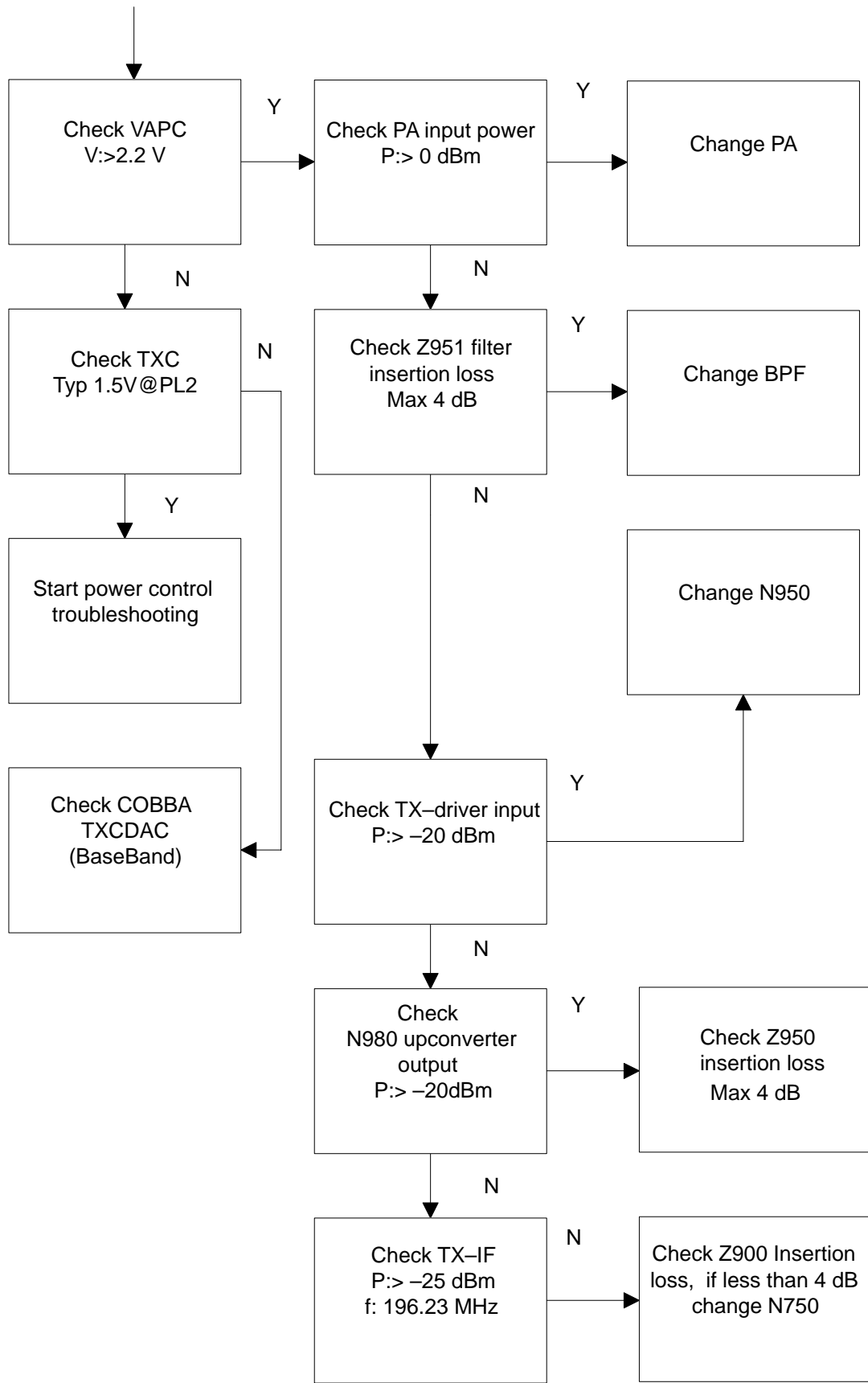



### Power Control Loop

Power control section is basically similar for both band except both bands include a coupler and detector. The power control is actually effected in the PLUSSA IC.

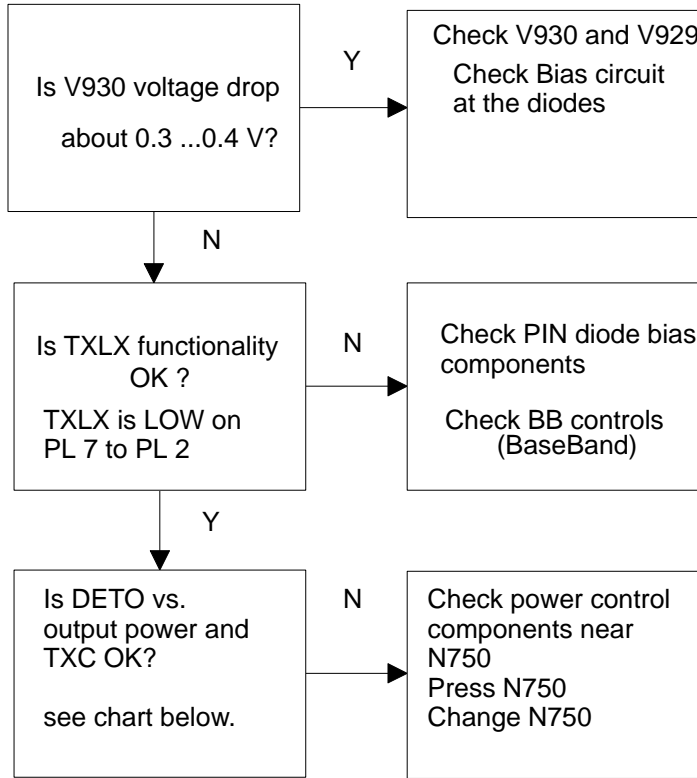

Note !

See DETO vs. Output power.

Note !

1. Gain control voltage of driver is directly proportional to output power and TXC voltage in AMPS MODE.
2. Gain coltrol voltage of driver will remain same (+/- 2dB typ.) regardless of power level and TXC voltage in DIGITAL MODE.
3. DETO and TXC will be about same in each mode.
4. TXA is high during modulation.
5. TXLX signals will draw about 4mA current in HIGH state.

Typical detected voltage level at different power levels, +32 C:

HD961/HD963			
LB:			
PL		TXC	
	10	-348	0.36736
	9	-319	0.43232
	8	-283	0.51296
	7	-324	0.42112
	6	-291	0.49504
	5	-243	0.60256
	4	-170	0.76608
	3	-61	1.01024
	2	106	1.38432
UB:			
PL		TXC	
	10	-352	0.3584
	9	-313	0.44576
	8	-259	0.56672
	7	-291	0.49504
	6	-262	0.56
	5	-225	0.64288
	4	-163	0.78176
	3	-46	1.04384
	2	74	1.31264
NOTE: DAC VALUES MAY VARY +/- 150 DAC UNITS			

## Synthesizers

There are four oscillators generating the needed frequencies for RF-section. They are

19.44 MHz reference oscillator,	
1GHz UHF VCO frequency range	985.23 ... 1010.2 MHz
2Ghz UHF VCO frequency range	2046.2 ... 2107.2 Mhz
VHF VCO has two fixed frequencies,	322.38 Mhz for lowband
	392.46 for upper band

VHF VCO operating frequency is controlled by the BAND-signal and the PLL-circuit of the PLUSSA. All locals are locked to a stable reference oscillator.

A practical way to check the synthesizer status is measuring the control voltage of the VCO from the Integrator capacitor. If the voltage is stable and reasonable, the local oscillators are running correctly.

### 19.44 MHz reference oscillator

The 19.44 MHz oscillator frequency (G850) is controlled by the COBBA\_D. This signal is fed to the PLUSSA and TDMA1900 PLL circuit. All synthesizers use the divided signal as reference signal for the phase locked loop to provide a correct LO frequency. The VCTCXO output signal is also used to generate the 2LO frequency by multipliers.

The baseband clock signals are generated from this signal. The VCTCXO output signal is buffered and connected to MAD2.

### 58.32 MHz 3-multiplier

The 3-multiplier is a discrete circuit which is used to generate the second local frequency for the receiver. The multiplier output signal is connected to the PLUSSA IN\_X2 pin. In the PLUSSA the signal is multiplied by 2 and then fed to the 2nd mixer.

### 19.44 MHz oscillator and 3-multiplier troubleshooting

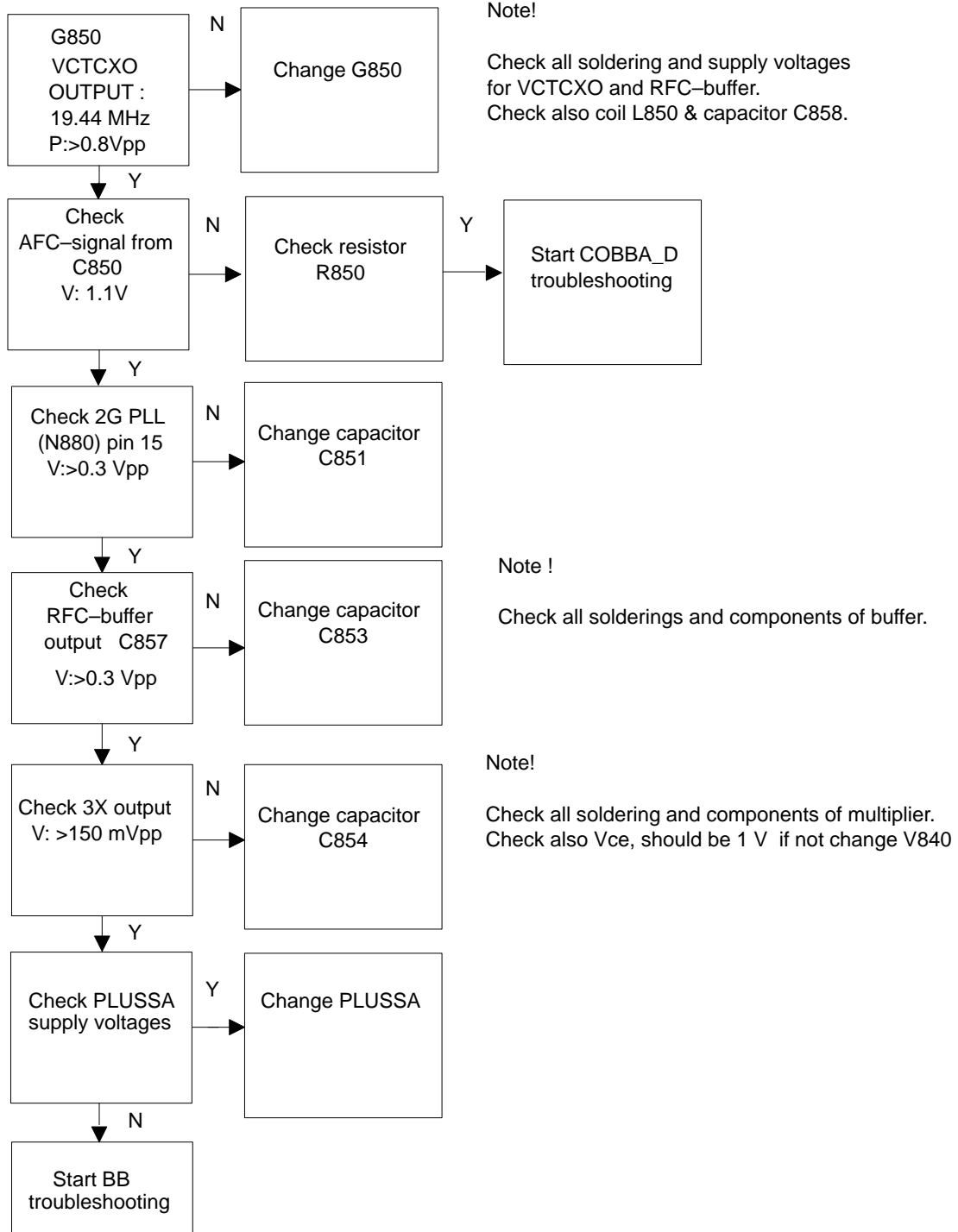

## VHF VCO

The VHF VCO signal is used to generate the transmitter intermediate frequencies. The VHF VCO has two fixed frequencies. The operating frequency is locked in phase locked loop which is controlled by the baseband

Because the oscillator employs two frequencies it also has two different switching modes. These modes are controlled by the BAND signal. In AMPS and TDMA800 modes the frequency is 322.38 MHz and the logical level of the BAND signal is "HIGH". In TDMA1900 mode a higher frequency is needed and the operating frequency is increased to 392.46 MHz. The BAND signal is also set to logical level "zero"

The VHF VCO output signal is fed to the PLUSSA LO pin no.8. In the PLUS-SA the signal is divided for the phase detector and TX elements. Before being fed to the I/Q-modulator the frequency is divided by 2.

### VHF VCO troubleshooting

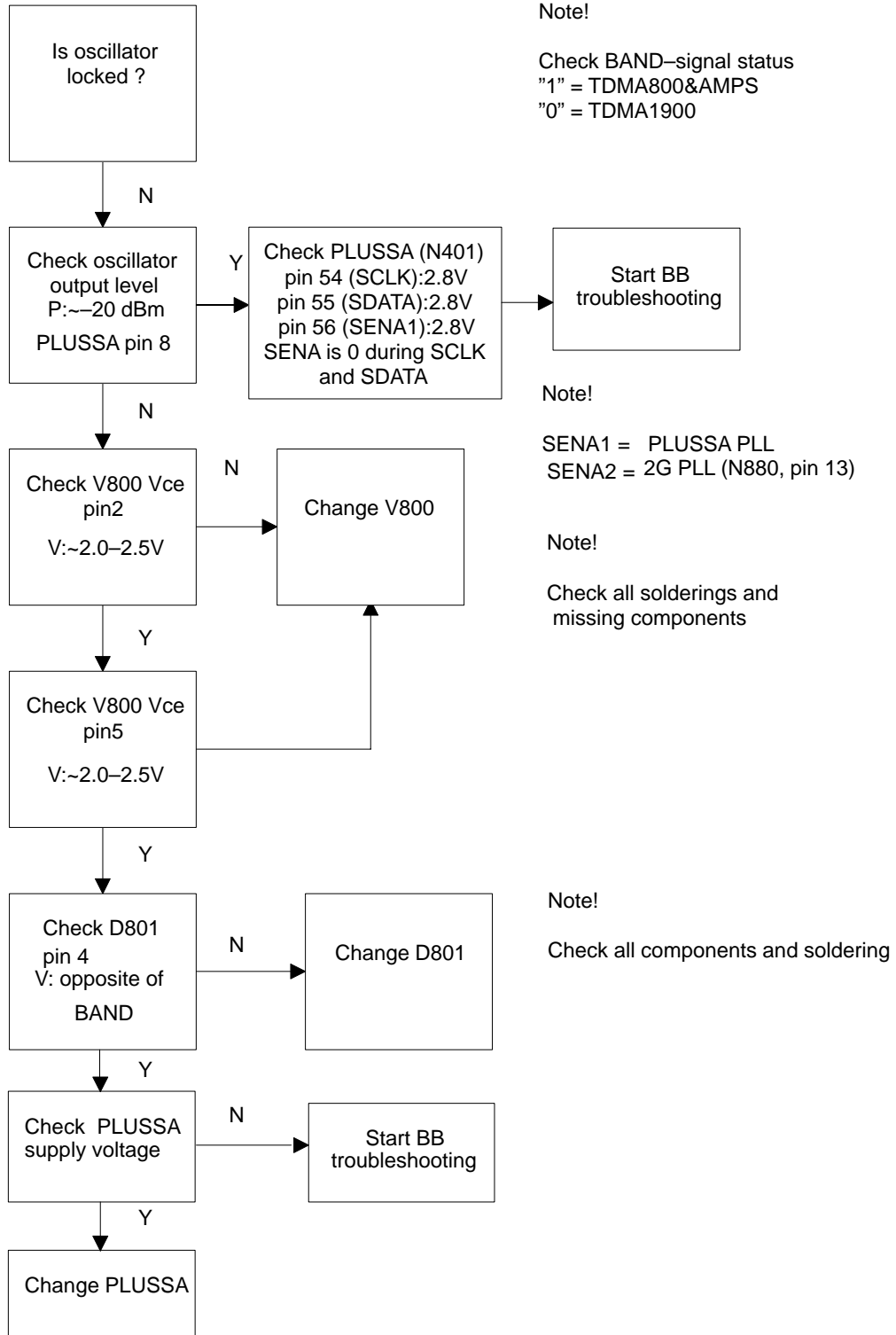

### AMPS & TDMA UHF SYNTHESIZER

The 1GHz UHF VCO (G820) generates the first injection for RX (869...897MHz) and the final injection for TX (824...849 MHz) . The output frequency of the module depends on the DC control voltage supplied by the PLUSSA.

### 1GHz UHFsynthesizer troubleshooting

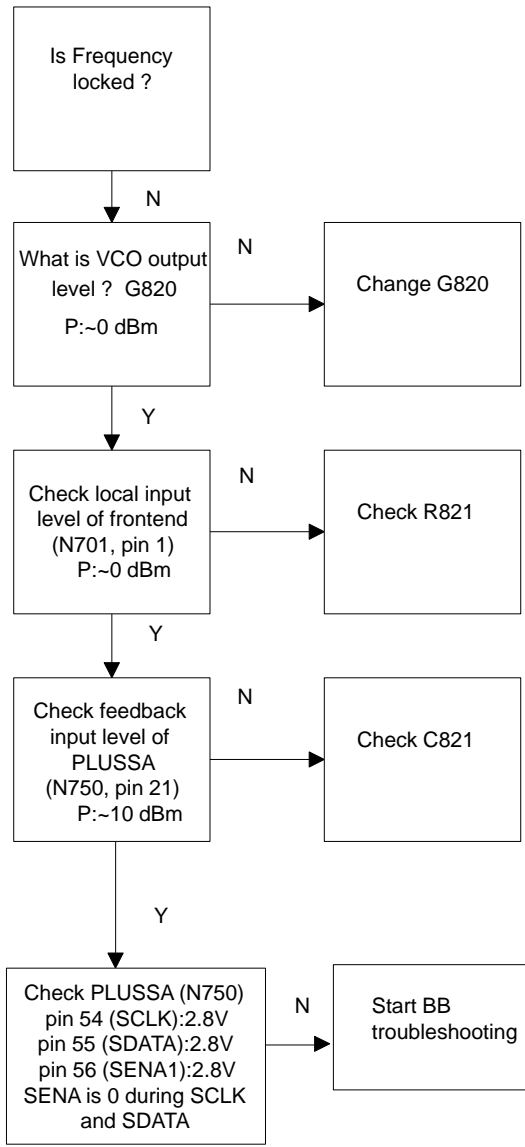

Note!

The oscillator is locked when the frequency and Vcnt are stable.

Frequency = 985.23...1010.2  
Vcnt = 1.2...3.6 V  
(C831)

Note!

Check all soldering & missing components and supply voltage

Note !

Check PLUSSA supply voltages

## TDMA1900 UHF Synthesizer 2 GHz (ONLY DUALBANDER)

The 2GHz UHF synthesizer generates the needed injection frequencies for TX and RX chain. The output frequency of the VCO depends on the control voltage supplied by the PLL circuit.

### 2 GHz UHF synthesizer troubleshooting

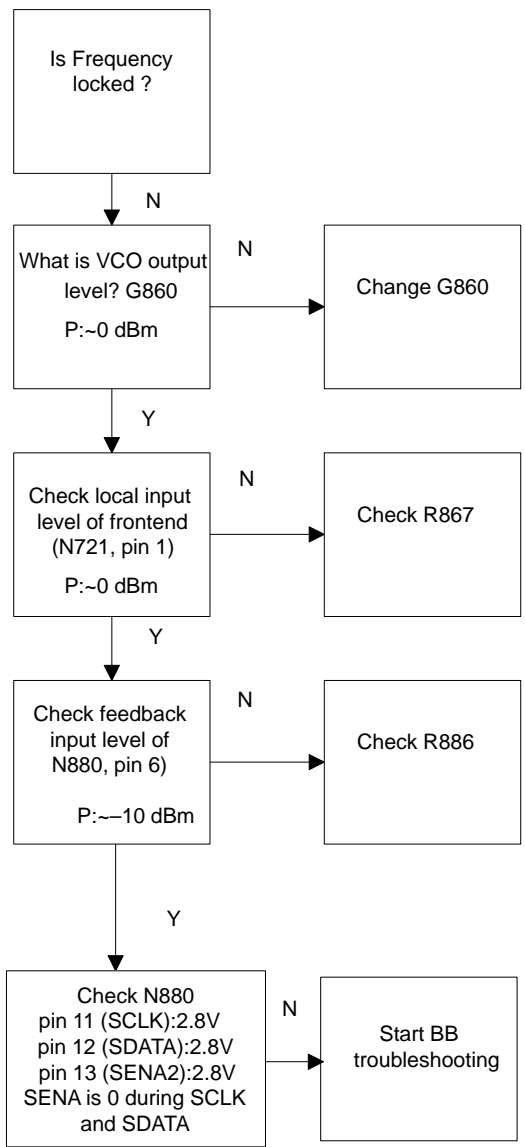

Note!  
Frequency = 985.23...1010.2  
Vcnt = 1.2...3.6 V , C861

Note!  
Check all soldering & missing components  
and supply voltage.

Note!  
Check N880  
supply voltages

## About RF ASICs and MMIC PA

### General information

The PLUSSA (N750) provides two main functions:

1. RX/TX blocks
2. PLL

The receiver block consists of IF buffers, active mixers, 2-multiplier, AGC amplifier and limiter.

The transmitter section includes a digital gain step amplifier, a divider, an I/Q Modulator and control part for the Transmitter Power Control loop.

The PLL section is controlled via the serial bus and contains both UHF and VHF PLL and predividers.

### PLUSSA ASIC

Pin #	Pin name	Nominal level	Description
1	TXP_pwc	2.8V	TX power control enable
2	TXA_pwc	2.8V	TX power loop control mode
3	INPi_tx	0.8V	Positive I-channel input of the TX
4	INMi_tx	0.8V	Negative I-channel input of the TX
5	INMq_tx	0.8V	Positive Q-channel input of the TX
6	INPq_tx	0.8V	Negative Q-channel input of the TX
7	GND_P1	0	Ground
8	LO	?	VHF VCO signal
9	VP1	2.8V	VHF prediv supply voltage from CCONT
10	VOP	2.8V	Positive supply voltage for the 1st opamp in pwrctrl
11	TXC_pwc	0.5-2V	Power level control of the TX
12	DET_pwc	?	Feedback from the peak detector diode
13	TXI_pwc	-	False transmission indicator
14	opain_pwc	-	Input for the 2nd opamp in the pwr ctrl loop
15	opout_pwc	-	Opamp output for external feedback
16	OUT_pwc	-	Output voltage for TX-driver
17	VCE1	~5V	VHF charge pump V5V-signal from BB
18	PD	?	VHF charge pump output
19	VSE1	0	Ground for VHF charge pump
20	DGND	0	Digital ground
21	OSC	?	19.44 MHz-signal from G850
22	VDD	2.8V	Positive supply for digital parts
23	GND_P2	0	Ground for UHF predivider
24	U_in	0dBm	UHF VCO signal from G820
25	VP2	2.8V	Positive supply for UHF predivider
26	VSE2	0	Negative supply for UHF charge pump
27	PD2	-	UHF charge pump output



28	VCE2	~5V	V5V–signal for UHF charge pump from BB
29	OUTP_rxif	?	Positive output of the receiver output gain stage
30	OUTM_rxif	?	Negative output of the receiver output gain stage
31	LIMOUT2	–	Negative output of the limiter amplifier
32	LIMOUT1	–	Positive output of the limiter amplifier
33	RSSI	–	Received signal strenght indicator voltage
34	INM_rxif	?	Negative input of the receiver output gain stage
35	INP_rxif	?	Positive input of the receiver output gain stage
36	LIMIN2		AC ground of limiter offset comp feedback
37	LIMIN1		Limiter amplifier input
38	LIMD1		AC ground of limiter offset comp feedback
39	UB_a2		Filtering cap for bias of lim amplifier
40	VRX_lim1	–	Positive supply of lim amplifier and RSSI
41	GND_if2	0	Ground
42	IN_X2	–	Input to x2–frequency multiplier
43	Vcc_x2	–	Positive supply of x2 block
44	OUTP_rx	?	Positive mixer output of the receiver
45	OUT_rx_a		Positive output of analog mode RX mixer
46	UB_a1	–	Filtering cap for bias of analog mode RX
47	VRX	2.8V	Power supply of the receiver
48	GND_if1	0	Ground
49	INP_a	–	Positive input of analog mode rx amplifier
50	INN_a	–	Negative input of analog mode rx amplifier
51	INM_rx	–	Negative input of the receiver
52	INP_rx	–	Positive input of the receiver
53	GC_rx	?	RX gain control signal
54	SCLK	0.8–2V	Clock for PLL serial programming and digital gain step amplifier adjusting
55	SDAT	0.8–2V	Data for PLL serial programming and digital gain step adjusting
56	SLE	0.8–2V	Latch enable for PLL serial programming and digital gain step adjusting
57	VB2_rx	0	Connection for filtering capacitor of Bias voltage of RX&TX
58	VB_ext	1.5V	VREF–signal from BB
59	IB	0	Internal Bias voltage
60	GND	0	Ground
61	OUTN_tx	?	Negative output of the transmitter
62	OUTP_tx	?	Positive output of the transmitter
63	VTX	2.8V	Positive power supply of the transmitter
64	LO_out		Not connected

**Receiver front ends**

Pin #	Pin name	Nomi- nal lev- el	Description
1	LO IN	?	Mixer lo input
2	Vdd buf	2.8V	Lo-buffer Vdd
3	LO out		Lo-buffer output
4	GND	0	ground
5	Vdd LNA	2.8V	LNA Vdd
6	GND	0	ground
7	LNA in	?	LNA RF input port
8	GND	0	LNA ground
9	Gain sel		LNA gain select
10	LNA out		LNA output port
11	GND	0	ground
12	Mxr RF	?	Mixer RF input port
13	GND	0	ground
14	MXR IF	?	Mixer IF input port
15	GND	0	ground
16	Vdd MXR	?	Mixer lo-buffer Vdd and lo-buffer tuning

**MMIC Power Amplifiers**

Pin #	Pin name	Nomi- nal lev- el	Description <b>N960</b>
1	Vcc	VBAT	Power supply for bias circuit
2	N/C	–	Not connected
3	LTune	?	Tuning pin for interstage matching network
4	Vcc1	VBAT	Power supply for the 1st stage collector
5	GND1	–	Ground
6	RF IN		RF input
7	N/C	–	Not connected
8	Vreg	2.8V	Regulated power supply for bias circuit. PA shut down
9	N/C		Not connected
10	N/C		Not connected
11	N/C		Not connected
12	RF OUT	?	RF output and bias for output stage
13	RF OUT	?	RF output and bias for output stage
14	2*fo	?	Second harmonic trap
15	N/C		Not connected
16	Vbias	–	Bias control 2.8V
Package Base	Ground	–	Ground connection. The backside of the package must be connected to the ground plane through a short path

Pin #	Pin name	Nomi- nal lev- el	Description <b>N960</b>
1	N/C		Not connected
2	N/C		Not connected
3	Vcc/Q2C	VBAT	Power supply for the 2nd stage
4	Vcc/Q1C	VBAT	Power supply for the 1st stage.
5	GND	–	Ground
6	RF IN	?	RF input
7	GND	–	Ground
8	Vreg	2.8V	Regulated voltage supply for the bias circuit
9	N/C		Not connected
10	Bias		Bias ground
11	RF OUT	?	RF output matching
12	RF OUT	?	RF output and bias for output stage
13	RF OUT	?	RF output and bias for output stage
14	RF OUT	?	Second harmonic trap
15	N/C		Not connected
16	N/C		Not connected
Package Base	Ground	–	Ground connection. The backside of the pack- age must be connected to the ground plane through a short path

### PENTA regulator

Pin #	Pin name	Nomi- nal lev- el	Description
1	Bypass	–	Pin for external bypass capacitor
2	Common enable	?	Enable for whole circuit
3	VR1cntrl		Regulator 1 ON/OFF
4	VR2cntrl		Regulator 2 ON/OFF
5	VR3cntrl		Regulator 3 ON/OFF
6	VR4cntrl		Regulator 4 ON/OFF
7	VR5cntrl		Regulator 5 ON/OFF
8	GND		Ground
9	VR5	2.8V	Regulator 5 output
10	Vcc2	VBAT	VR4 and VR5 common input voltage
11	VR4	2.8V	Regulator 4 output
12	VR3	2.8V	Regulator 3 output
13	VR2	2.8V	Regulator 2 output
14	VR1	2.8V	Regulator 1 output
15	Vcc1	VBAT	VR1, VR2 and VR3 common input voltage
16	N/C		Not connected

**TDMA1900 UPCONVERTER**

Pin #	Pin name	Nominal level	Description
1	VDD1	2.8V	Supply voltage
2	N/C		Not connected
3	N/C		Not connected
4	GND	0	Ground
5	LO IN	?	TX local input
6	GND	0	Ground
7	RF OUT	?	RF output
8	VDD2	2.8V	Supply voltage
9	N/C		Not connected
10	N/C	–	Not connected
11	GND	–	Ground
12	VDD3	2.8V	Supply voltage
13	GND	0	Ground
14	IF IN	–	Intermediate frequency input
15	N/C	–	Not connected
16	TX ENA		TX enable

**TDMA1900 PLL**

Pin #	Pin name	Nominal level	Description
1	FAST	2.8V	Enable input for fast chargepump
2	CPF		Fast charge pump output
3	CP		Normal charge pump output
4	VDD2	2.8V	Power supply voltage
5	Vss3	0	Ground
6	RFI	?	Main divider input
7	Vss2	0	Ground
8	POL	2.8V	polarity select
9	PON	2.8V	Power on input
10	Vss1	0	Ground
11	CLK	?	Programming bus clock input
12	DATA	?	Programming bus data input
13	E	?	Programming bus enable input
14	Vdd1	–	Power supply voltage
15	XTALB	–	Complementary crystal frequency input
16	XTALA	–	Complementary crystal frequency input
17	GND(CP)	0	Ground for charge pump
18	Vcc	4.8V	Supply voltage for charge pump
19	Iset	–	charge pump currents setting
20	LOCK	–	Out of lock detector